

ignion[™]

Your innovation.
Accelerated.

BAR mXTEND[™]: A STANDARD ANTENNA SOLUTION FOR MOBILE FREQUENCY BANDS

APPLICATION NOTE
BAR mXTEND[™] (NN02-232)

BAR mXTEND™: A STANDARD ANTENNA SOLUTION FOR MOBILE FREQUENCY BANDS

Ignion specializes in enabling effective mobile communications. Using Ignion technology, we design and manufacture optimized antennas to make your wireless devices more competitive. Our mission is to help our clients develop innovative products and accelerate their time to market through our expertise in antenna design, testing and manufacturing.



BAR mXTEND™

NN02-232

Ignion products are protected by [Ignion patents](#).

All information contained within this document is property of Ignion and is subject to change without prior notice. Information is provided “as is” and without warranties. It is prohibited to copy or reproduce this information without prior approval.

Ignion is an ISO 9001:2015 certified company. All our antennas are lead-free and RoHS compliant.

ISO 9001: 2015 Certified

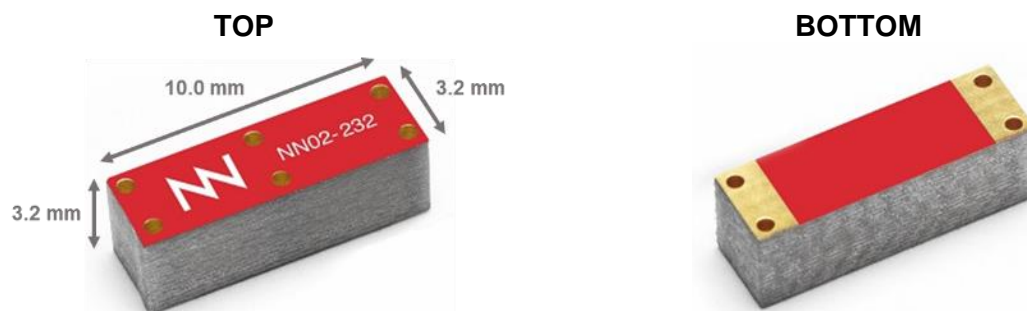

TABLE OF CONTENTS

1. ANTENNA DESCRIPTION	4
2. EVALUATION BOARD 3 PORTS (698-798MHz, 824-960MHz, 1710-2690MHz)	5
2.1. QUICK REFERENCE GUIDE	5
2.2. EVALUATION BOARD 3 PORTS	5
2.3. MATCHING NETWORK	6
2.4. VSWR AND TOTAL EFFICIENCY	8
2.5. TRANSMISSION COEFFECIENT	9
2.6. RADIATION PATTERNS (698-798 MHz), GAIN AND EFFICIENCY	10
2.7. RADIATION PATTERNS (824-960 MHz), GAIN AND EFFICIENCY	11
2.8. RADIATION PATTERNS (1710-2690 MHz), GAIN AND EFFICIENCY	12
3. ANTENNA FOOTPRINT FOR NN02-232 DOUBLE BOOSTER	13

1. ANTENNA DESCRIPTION

The BAR mXTEND[™] antenna booster has been specifically designed for providing multiband performance in wireless devices (in particular in mobile devices), enabling worldwide coverage by allowing operation in the communication standards GSM850, GSM900, GSM1800/DCS, GSM1900/PCS, UMTS, LTE700, LTE800, LTE850, LTE900, LTE1700, LTE1800, LTE1900, LTE2000, LTE2100, LTE2300, LTE2500, and LTE2600.



Material: The BAR mXTEND[™] antenna booster is built on glass epoxy substrate.

APPLICATIONS

- Handsets
- Smartphones
- Tablets
- Phablets
- Laptop PCs
- Netbooks
- Modules
- Routers
- eBooks

BENEFITS

- High efficiency
- Small size
- Cost-effective
- Easy-to-use (pick and place)
- Multiband behaviour (worldwide standards)
- Off-the-Shelf Standard Product (no customization is required)

The BAR mXTEND[™] antenna booster belongs to the new generation of antenna solutions based on the Virtual Antenna[™] technology developed by Ignion. The technology is mainly focused on replacing conventional antenna solutions by miniature and standard components.

2. EVALUATION BOARD 3 PORTS (698-798MHz, 824-960MHz, 1710-2690MHz)

2.1. QUICK REFERENCE GUIDE

Technical features	698 – 798 MHz	824 – 960 MHz	1710 – 2690 MHz
Average Efficiency	> 45.0 %	> 40.0 %	> 75.0 %
Peak Gain	1.3 dBi	0.3 dBi	3.8 dBi
VSWR	< 3:1		
Radiation Pattern	Omnidirectional		
Polarization	Linear		
Weight (approx.)	0.21 g		
Temperature	-40 to +125 °C		
Impedance	50 Ω		
Dimensions (L x W x H)	10.0 mm x 3.2 mm x 3.2 mm		

Table 1 – Technical features. Measures from the Evaluation Board. See Figure 1. Note that for obtaining comparable results, a ground plane length larger than 100 mm is recommended.

2.2. EVALUATION BOARD 3 PORTS

This Evaluation Board (part number: EB_NN02-232-UFL3R) integrates UFL cables to connect the BAR mXTEND™ antenna boosters with the SMA connector. It works from 698 MHz to 798 MHz, from 824 MHz to 960 MHz, and from 1710 MHz to 2690 MHz.

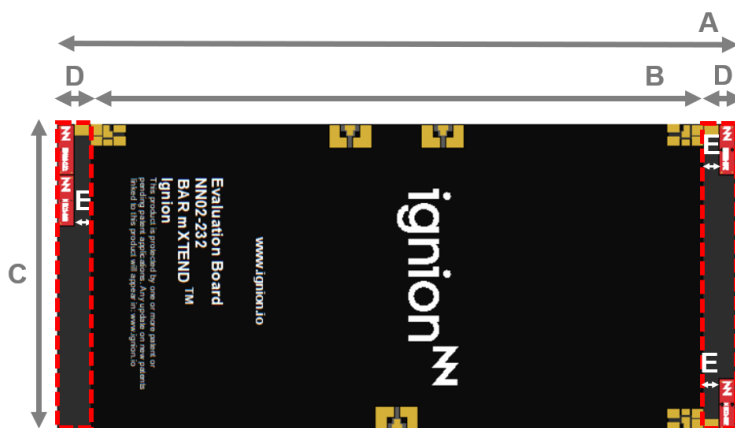

Measure	mm
A	133.0
B	120.0
C	60.0
D	6.5
E	3.3

Tolerance: ±0.2 mm

Material: The Evaluation Board is built on FR4 substrate. Thickness is 1 mm.

E: Distance between the BAR mXTEND™ chip antenna component and the ground plane.

Clearance Area: 60 mm x 13 mm (Cx D)

Figure 1 – EB_NN02-232-UFL3R. Evaluation Board providing operation in 3 frequency ranges, 698 MHz to 798 MHz, 824 MHz to 960 MHz, and 1710 MHz to 2690 MHz.

This product is protected by at least the following [patents](#) PAT. US 8,203,492, PAT. US 8,736,497 and other domestic and international patents pending. Any update on new patents linked to this product will appear in www.ignion.io/virtual-antenna/.

Comments:

- Note that in this case the Evaluation Board (Figure 1) integrates two BAR mXTEND™ antenna boosters that are placed together to provide operation at LTE700 (698 – 798 MHz). Please see Figure 5 for the recommended footprint.
- The efficiency measures (Figure 3) are shown from 700 MHz due to the minimum frequency specifications of the Satimo STARGATE 32 anechoic chamber.

2.3. MATCHING NETWORK

The specs of a Ignion standard product are measured in their Evaluation Board, which is an ideal case. In a real design, components nearby the antenna, LCD's, batteries, covers, connectors, etc. affect the antenna performance. This is the reason why it is highly recommended to place pads compatible with 0402 and 0603 SMD components for a matching network as close as possible to the feeding point. Do it in the ground plane area, not in the clearance area. This provides a degree of freedom to tune the BAR mXTEND™ antenna booster once the design is finished and considering all elements of the system (batteries, displays, covers, etc.).

Please notice that different devices with different ground planes and different components nearby the BAR mXTEND™ antenna booster may need a different matching network. To ensure optimal results, the use of high Q and tight tolerance components is highly recommended (Murata components). If you need assistance to design your matching network beyond this application note, please contact support@ignion.io, or try our free-of-charge¹ **NN Wireless Fast-Track** design service, you will get your chip antenna design including a custom matching network for your device in 24h¹. Other related to NN's range of R&D services is available at: <https://www.ignion.io/rdservices/>

¹ See terms and conditions for a free NN Wireless Fast-Track service in 24h at: <https://www.ignion.io/fast-track-project/>

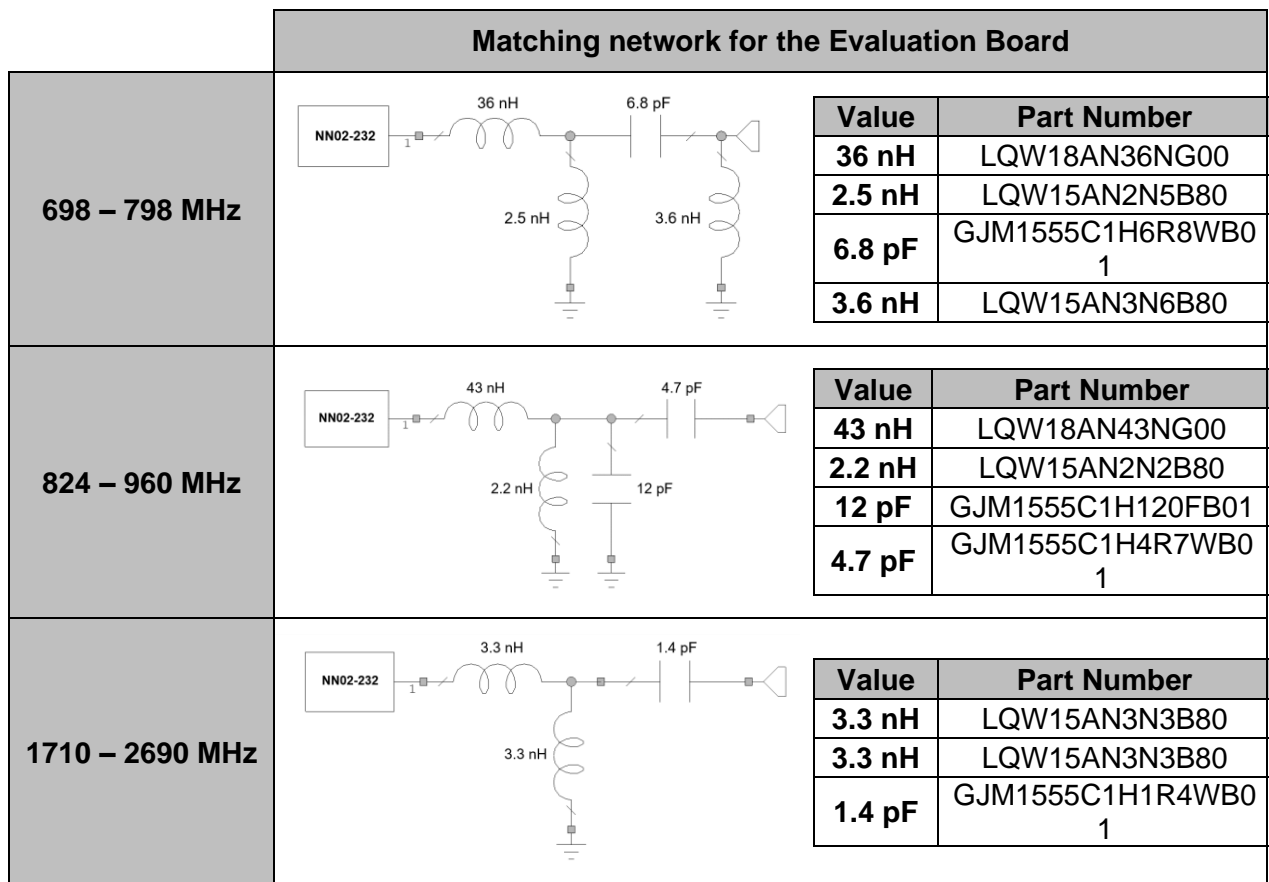

Figure 2 – Matching networks implemented in the Evaluation Board 3 ports (Figure 1).

2.4. VSWR AND TOTAL EFFICIENCY

VSWR (Voltage Standing Wave Ratio) and Total Efficiency versus Frequency (GHz).

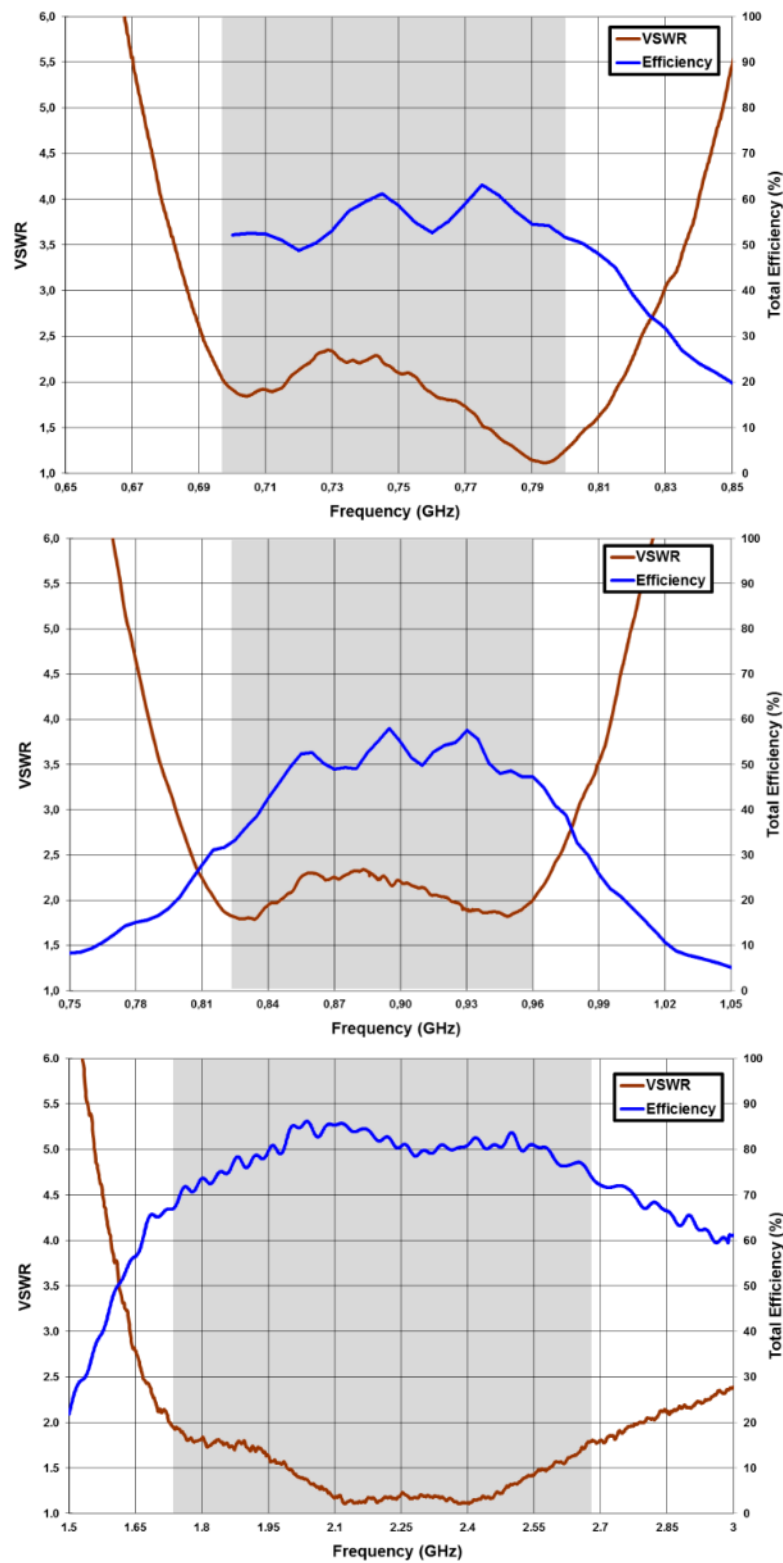

Figure 3 – VSWR and Total Efficiency for the 698 – 798 MHz range, for the 824 – 960 MHz range, and for the 1710 – 2690 MHz range from the Evaluation Board 3 ports (Figure 1).

2.5. TRANSMISSION COEFFICIENT

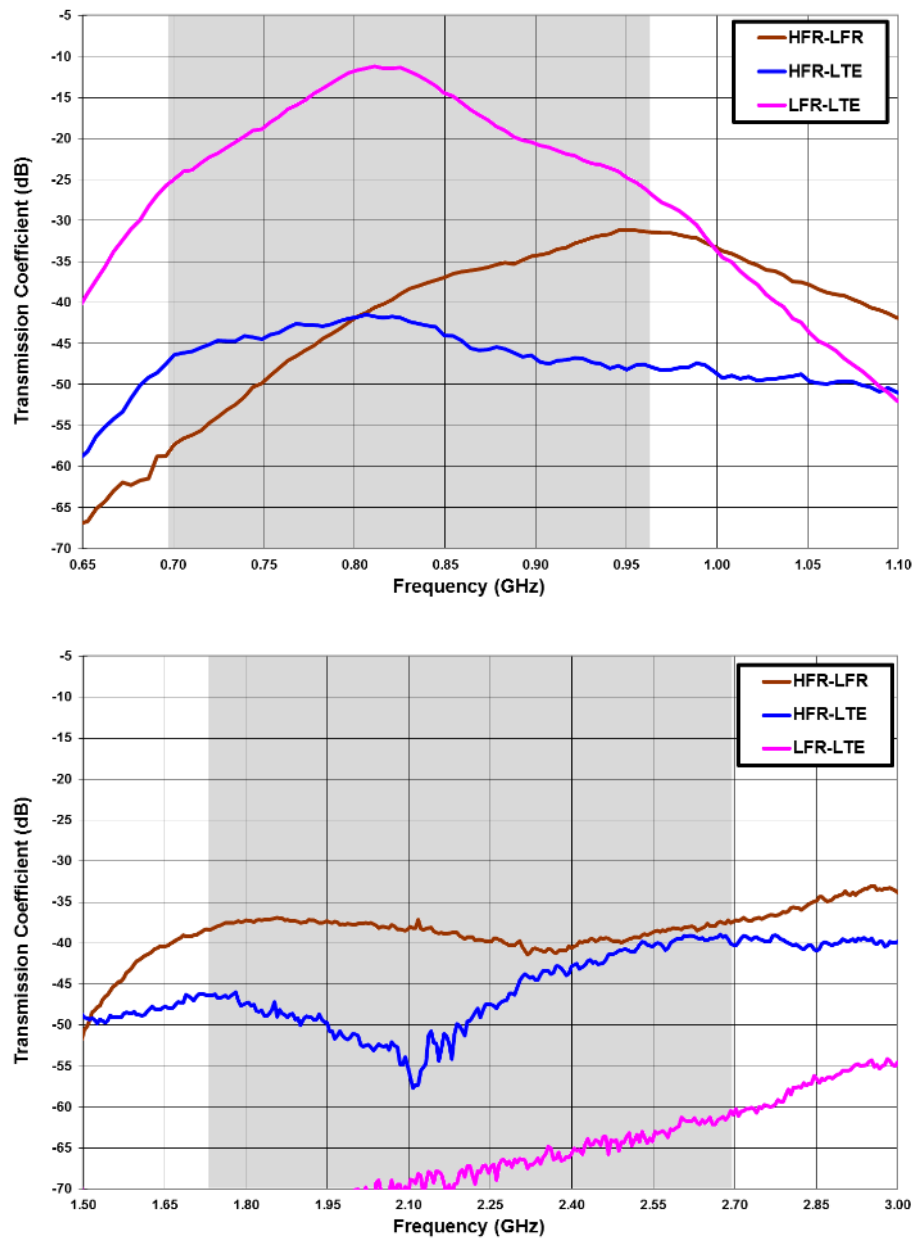
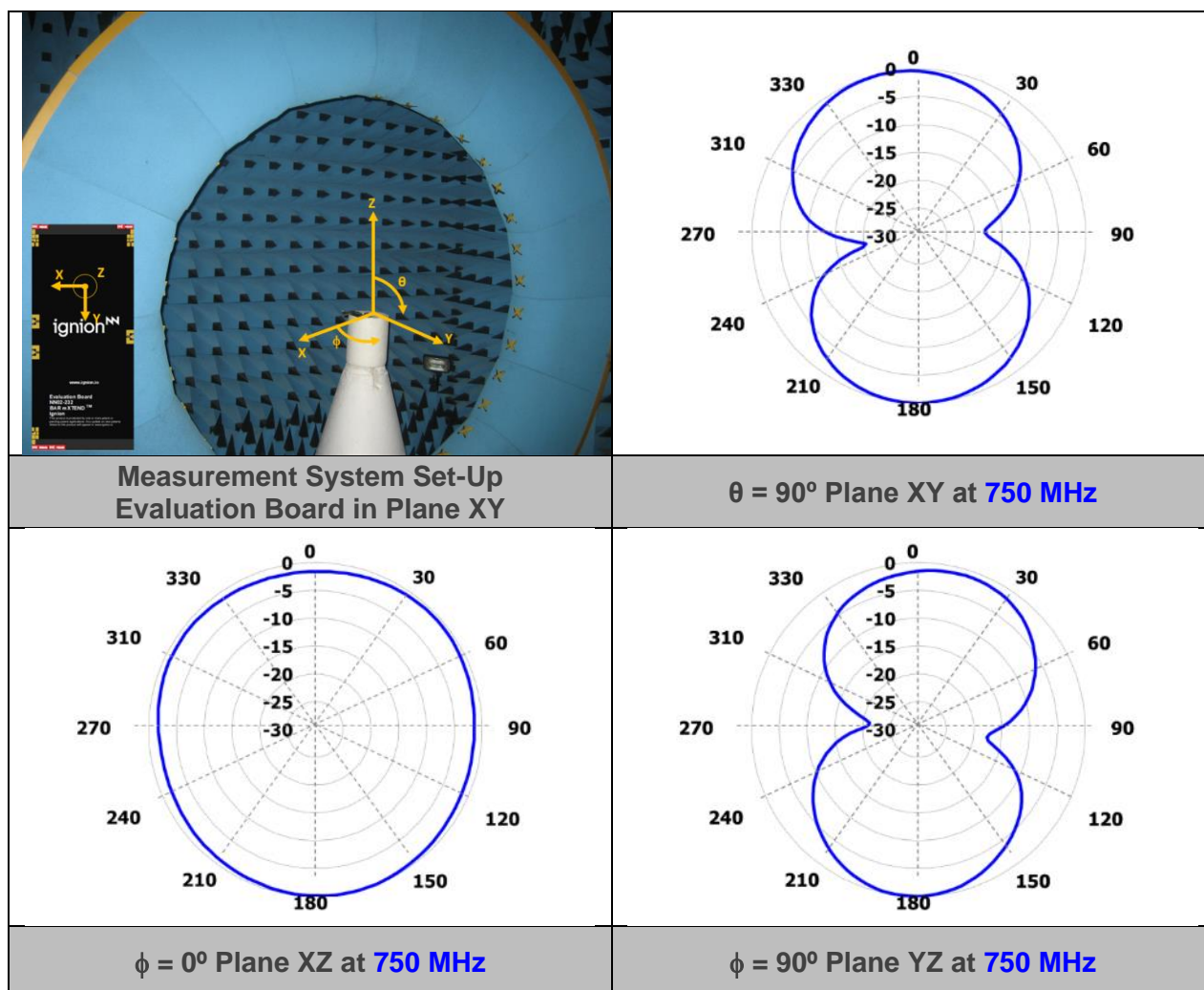

Figure 4 – Transmission coefficient for the 698-798 MHz range (LTE), for 824 – 960 MHz range (LFR), and for the 1710 – 2690 MHz range (HFR) (from the Evaluation Board 3 ports) (Figure 1).

2.6. RADIATION PATTERNS (698-798 MHz), GAIN AND EFFICIENCY



Gain	Peak Gain	1.3 dBi
	Average Gain across the band	0.3 dBi
	Gain Range across the band (min, max)	-0.6 \leftrightarrow 1.3 dBi
Efficiency	Peak Efficiency	63.1 %
	Average Efficiency across the band	55.5 %
	Efficiency Range across the band (min, max)	48.8 – 63.1 %

Table 2 – Antenna Gain and Total Efficiency from the Evaluation Board (Figure 1) within the 698 – 798 MHz range. Measures made in the Satimo STARGATE 32 anechoic chamber.

2.7. RADIATION PATTERNS (824-960 MHz), GAIN AND EFFICIENCY

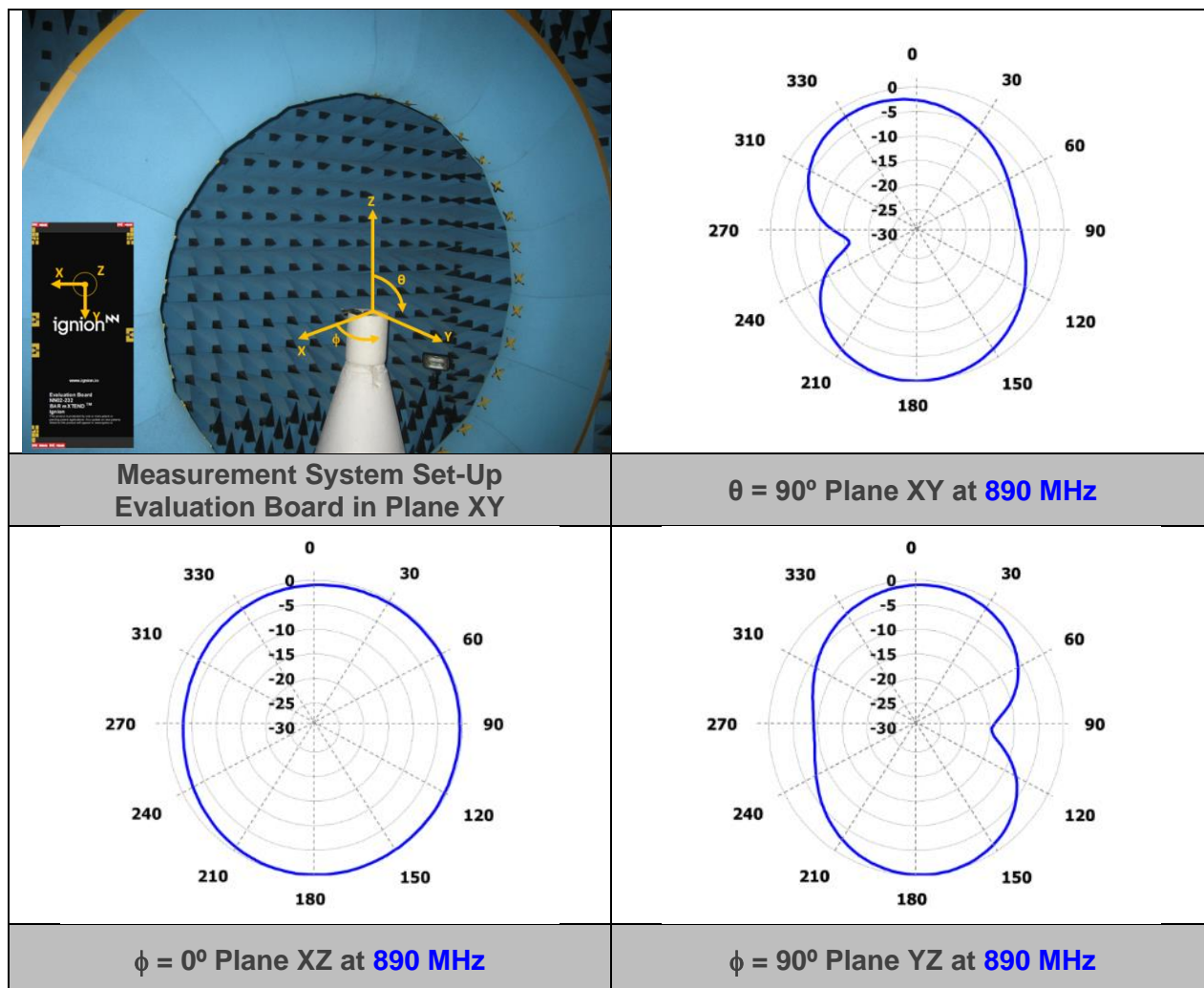

Gain	Peak Gain	0.3 dBi
	Average Gain across the band	-0.3 dBi
	Gain Range across the band (min, max)	-2.2 \leftrightarrow 0.3 dBi
Efficiency	Peak Efficiency	58.0 %
	Average Efficiency across the band	49.8 %
	Efficiency Range across the band (min, max)	33.0 – 58.0 %

Table 3 – Antenna Gain and Total Efficiency from the Evaluation Board (Figure 1) within then 824 – 960 MHz range. Measures made in the Satimo STARGATE 32 anechoic chamber.

2.8. RADIATION PATTERNS (1710-2690 MHz), GAIN AND EFFICIENCY

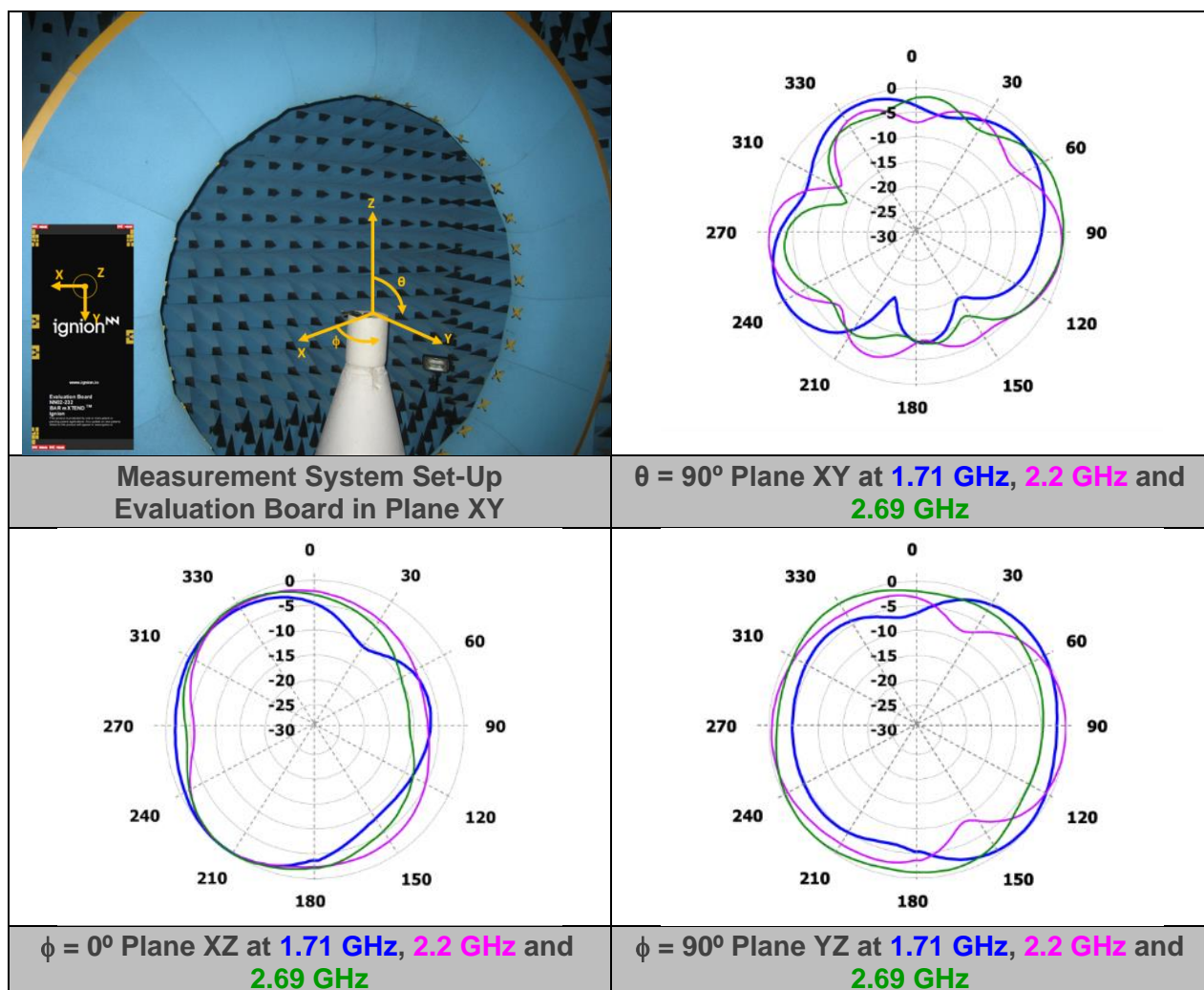

Gain	Peak Gain	3.8 dBi
	Average Gain across the band	3.1 dBi
	Gain Range across the band (min, max)	1.9 ↔ 3.8 dBi
Efficiency	Peak Efficiency	87.9 %
	Average Efficiency across the band	79.3 %
	Efficiency Range across the band (min, max)	65.9 – 87.9 %

Table 4 – Antenna Gain and Total Efficiency from the Evaluation Board (Figure 1) within the 1710 – 2690 MHz range. Measures made in the Satimo STARGATE 32 anechoic chamber.

3. ANTENNA FOOTPRINT FOR NN02-232 DOUBLE BOOSTER

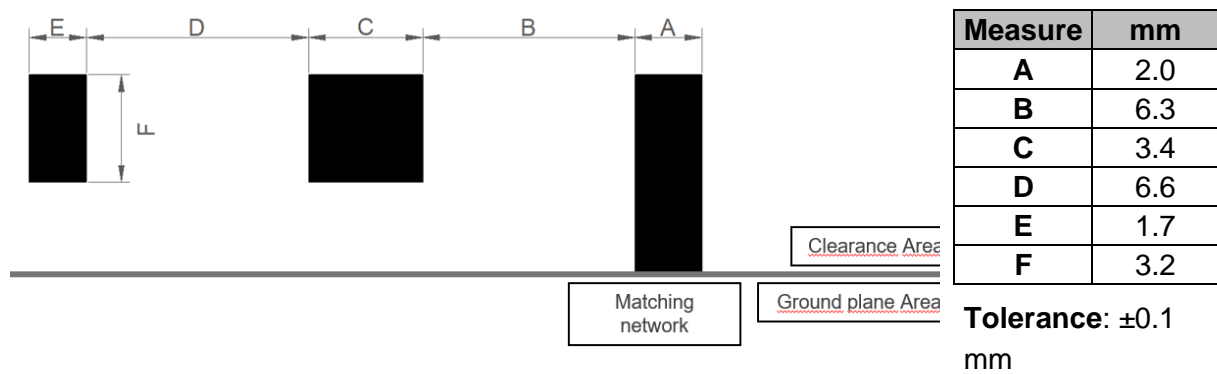

Figure 5 – Footprint dimensions for the double booster.

For additional support in the integration process, please contact support@ignion.io.

ignion[™]

Your innovation.
Accelerated.

Contact:
support@ignion.io
+34 935 660 710

Barcelona

Av. Alcalde Barnils, 64-68 Modul C, 3a pl.
Sant Cugat del Vallés
08174 Barcelona
Spain

Shanghai

Shanghai Bund Centre
18/F Bund Centre, 222 Yan'an Road East,
Huangpu District
Shanghai, 200002
China

New Dehli

New Delhi, Red Fort Capital Parsvnath Towers
Bhai Veer Singh Marg, Gole Market,
New Delhi, 110001
India

Tampa

8875 Hidden River Parkway
Suite 300
Tampa, FL 33637
USA