

ignion<sup>™</sup>

Your innovation.  
Accelerated.

# Unleash your smartwatch's antenna performance

APPLICATION NOTE  
RUN mXTEND<sup>™</sup> (NN02-224)

## LOOKING TO MAINTAIN PEAK PERFORMANCE IN YOUR SMARTWATCH?

### RUN mXTEND<sup>™</sup> (NN02-224) – AN for a Smartwatch WIFI/BLUETOOTH (2400-2500 MHz)

Ignion specializes in enabling effective mobile communications. Using Ignion technology, we design and manufacture optimized antennas to make your wireless devices more competitive. Our mission is to help our clients develop innovative products and accelerate their time to market through our expertise in antenna design, testing and manufacturing.



RUN mXTEND<sup>™</sup> antenna booster

NN02-224

Ignion products are protected by [Ignion patents](#).

All information contained within this document is property of Ignion and is subject to change without prior notice. Information is provided “as is” and without warranties. It is prohibited to copy or reproduce this information without prior approval.

Ignion is an ISO 9001:2015 certified company. All our antennas are lead-free and RoHS compliant.

ISO 9001: 2015



## TABLE OF CONTENTS

<b>1. PRODUCT DESCRIPTION NN02-224</b>	<b>4</b>
<b>2. EVALUATION BOARD</b>	<b>5</b>
<b>2.1. QUICK REFERENCE GUIDE</b>	<b>5</b>
<b>2.2. EVALUATION BOARD (2.4-2.5 GHz)</b>	<b>5</b>
<b>2.3. MATCHING NETWORK</b>	<b>6</b>
<b>2.4. VSWR AND TOTAL EFFICIENCY</b>	<b>7</b>
<b>2.5. RADIATION PATTERNS (2.4 – 2.5 GHz), GAIN AND EFFICIENCY</b>	<b>8</b>
<b>3. HUMAN HAND IMPACT</b>	<b>9</b>
<b>3.1. SET-UP</b>	<b>9</b>
<b>3.2. MATCHING NETWORK</b>	<b>10</b>
<b>3.3. VSWR AND TOTAL EFFICIENCY</b>	<b>11</b>
<b>3.4. RADIATION PATTERNS, GAIN AND EFFICIENCY</b>	<b>12</b>

# 1. PRODUCT DESCRIPTION NN02-224

The RUN mXTEND™ antenna booster has been specifically designed for providing multiband performance in wireless devices, enabling worldwide coverage by allowing operation in multiple communication standards such as Bluetooth, ISM, WIFI, and WLAN.



**Material:** The RUN mXTEND™ antenna booster is built on glass epoxy substrate.

## APPLICATIONS

- Smartwatch
- Wearables
- M2M
- IoT
- Modules
- Meters
- Remote Sensors

## BENEFITS

- High efficiency
- Small size
- Cost-effective
- Easy-to-use (pick and place)
- Multiband behaviour (worldwide standards)
- Off-the-Shelf Standard Product (no customization is required)

The RUN mXTEND™ antenna booster belongs to a new generation of antenna solutions based on the Virtual Antenna® technology developed by Ignion. The technology is mainly focused on replacing conventional antenna solutions by miniature and standard components.

This project has received funding from the European Union's Horizon 2020 research and innovation programme under grant agreement N° 674491



## 2. EVALUATION BOARD

### 2.1. QUICK REFERENCE GUIDE

Technical features	2.4 – 2.5 GHz
Average Efficiency	> 75%
Peak Gain	2.2 dBi
VSWR	< 2:1
Radiation Pattern	Omnidirectional
Polarization	Linear
Weight (approx.)	0.19 g
Temperature	-40 to +125 °C
Impedance	50 Ω
Dimensions (L x W x H)	12.0 mm x 3.0 mm x 2.4 mm

Table 1 – Technical Features. Measures from the Evaluation Board (Figure 1).

### 2.2. EVALUATION BOARD (2.4-2.5 GHz)

This Evaluation Board EB\_NN02-224-SW-2400 integrates a coplanar grounded transmission line to connect the RUN mXTEND<sup>™</sup> antenna booster with the SMA connector. Its dimensions make it suitable for becoming an antenna system solution for smartwatches. The RUN mXTEND<sup>™</sup> provides operation in the frequency region which covers from 2.4 GHz to 2.5 GHz, through a single input/output port.

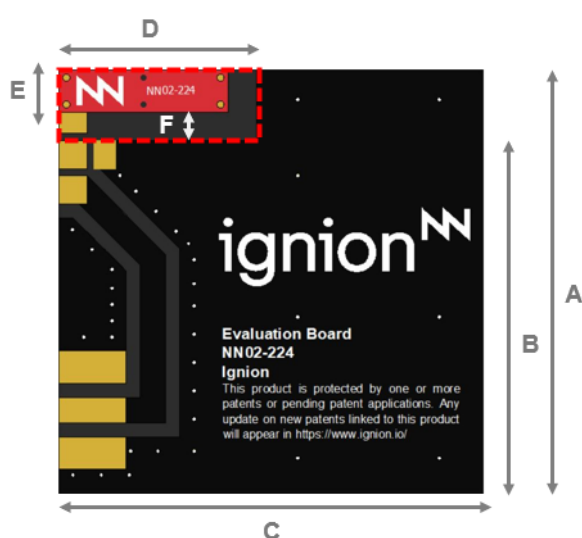

Measure	mm
A	30
B	25
C	30
D	14
E	5.0
F	2.0

Tolerance: ±0.2 mm

F: Distance between the RUN mXTEND<sup>™</sup> antenna booster and the ground plane.

**Material:** The Evaluation Board is built on FR4 substrate. Thickness is 1 mm.

**Clearance Area:** 5.0 mm x 14 mm (E x D)

Figure 1 – EB\_NN02-224-SW-2400. Evaluation Board providing operation from 2.4 GHz to 2.5 GHz.

This product and its use are protected by at least one or more of the following [patents](#) US 9,130,259 B2; US 9,276,307 B2 and patent applications US62/328073, <http://www.ignion.io/patents>. Additional information about patents related to this product is available at [www.ignion.io/virtual-antenna/](http://www.ignion.io/virtual-antenna/).

## 2.3. MATCHING NETWORK

The specs of a Ignion standard product are measured in their Evaluation Board, which is an ideal case. In a real design, components nearby the antenna, LCD's, batteries, covers, connectors, etc. affect the antenna performance. This is the reason why it is highly recommended placing pads compatible with 0402 and 0603 SMD components for a matching network as close as possible to the feeding point. Do it in the ground plane area, not in the clearance area. This provides a degree of freedom to tune the RUN mXTEND™ antenna booster once the design is finished and taking into account all elements of the series (batteries, displays, covers, etc.).

Please notice that different devices with different ground planes and different components nearby the RUN mXTEND™ antenna booster may need a different matching network. To ensure optimal results, the use of high Q and tight tolerance components is highly recommended (Murata components). Please, if you need assistance contact [support@ignion.io](mailto:support@ignion.io) for more information related to the antenna booster matching service.

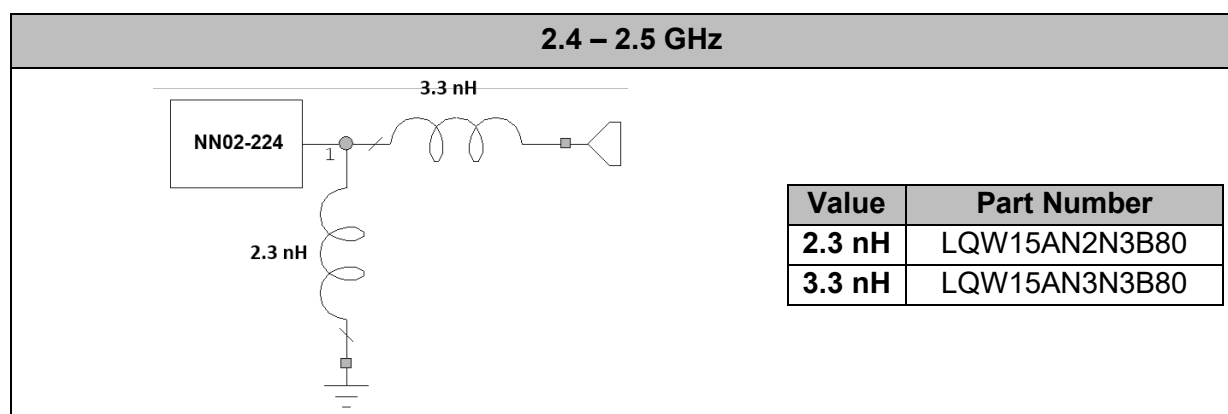

**Figure 2** – Matching Network implemented in the Evaluation Board (Figure 1).

For additional information, please visit [www.ignion.io](http://www.ignion.io) or contact [info@ignion.io](mailto:info@ignion.io).

If you need assistance to design your matching network beyond this application note, please contact [support@ignion.io](mailto:support@ignion.io), or if you are designing a **different device size** or a **different frequency band**, we can assist you in less than 24 hours. Please, try our free-of-charge<sup>1</sup> [Antenna Intelligence Cloud](https://www.ignion.io/antenna-intelligence/), which will get you a complete design report including a custom matching network for your device in 24h<sup>1</sup>. Additional information related to NN's range of R&D services is available at: <https://ignion.io/rdservices/>

<sup>1</sup> See terms and conditions for a free Antenna Intelligence Cloud service in 24h at: <https://www.ignion.io/antenna-intelligence/>

## 2.4. VSWR AND TOTAL EFFICIENCY

VSWR (Voltage Standing Wave Ratio) and Total Efficiency versus Frequency (GHz).

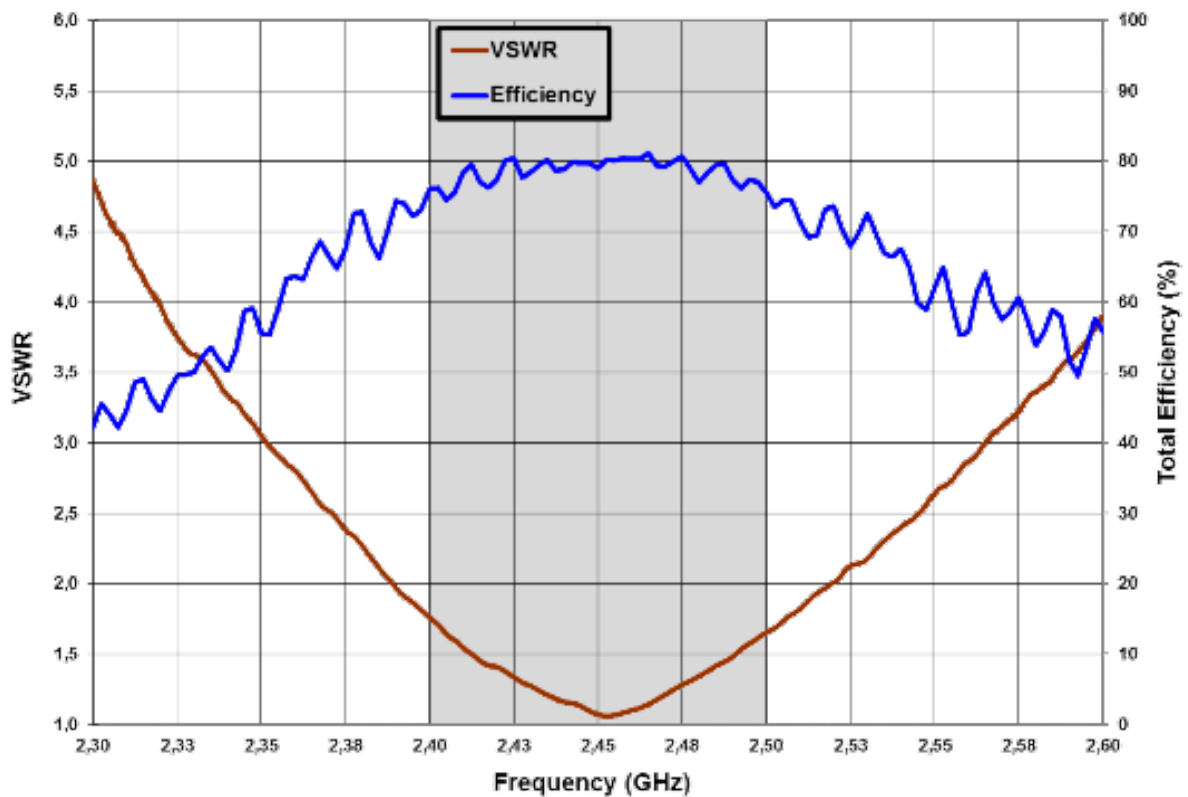

**Figure 3** – VSWR and Total Efficiency for the 2.4 – 2.5 GHz frequency range (from the Evaluation Board (Figure 1)).

## 2.5. RADIATION PATTERNS (2.4 – 2.5 GHz), GAIN AND EFFICIENCY

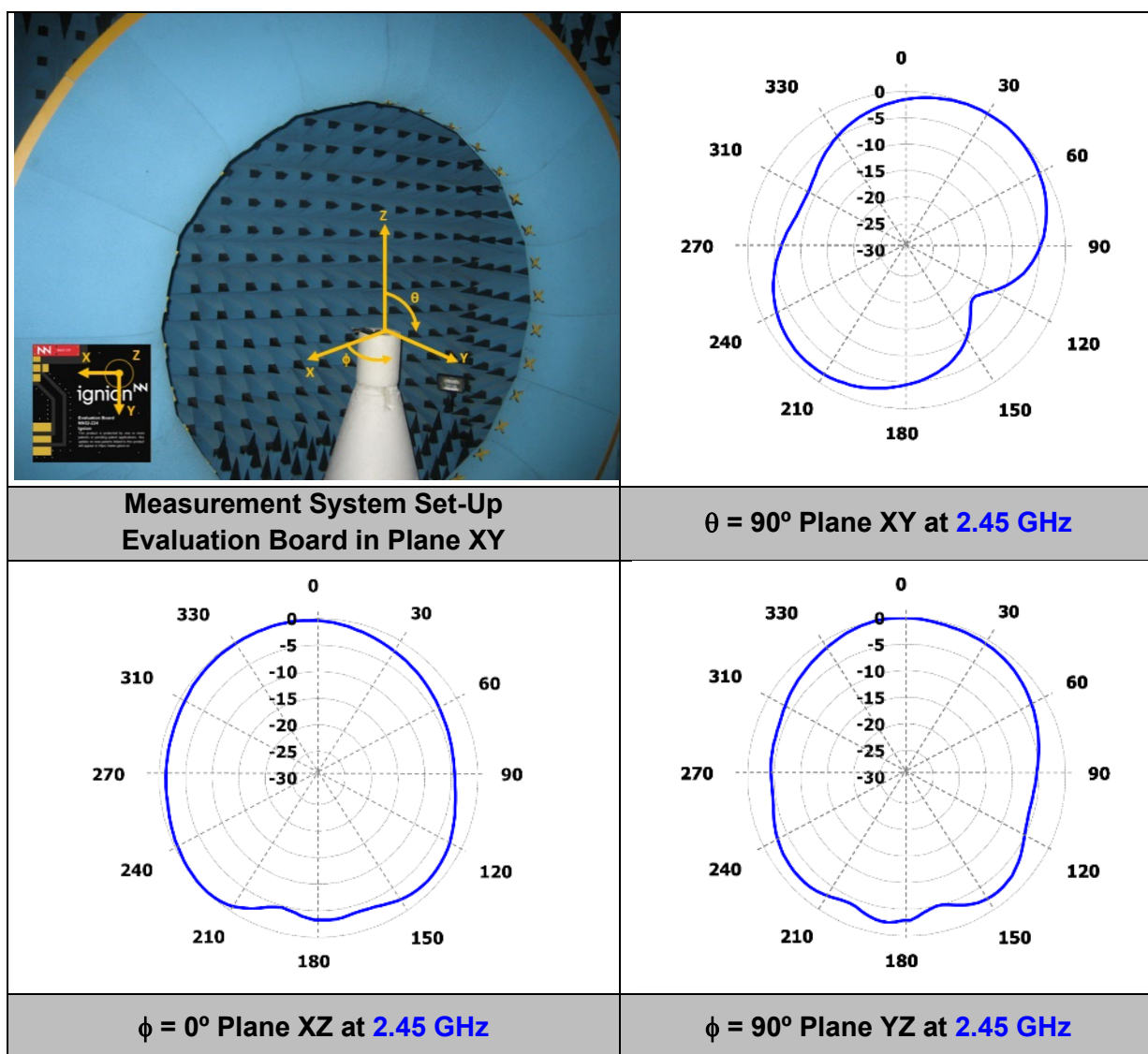

Gain	Peak Gain	2.2 dBi
	Average Gain across the band	1.9 dBi
	Gain Range across the band (min, max)	1.7 $\leftrightarrow$ 2.2 dBi
Efficiency	Peak Efficiency	81.2 %
	Average Efficiency across the band	78.6 %
	Efficiency Range across the band (min, max)	74.5 – 81.2 %

**Table 2** – Antenna Gain and Total Efficiency from the Evaluation Board (Figure 1) within the 2.4 – 2.5 GHz frequency range. Measures made in the Satimo STARGATE 32 anechoic chamber.



### 3. HUMAN HAND IMPACT

In general terms, the interaction of the human body with a radiating system affects its performance mainly introducing efficiency decrements and detuning effects. In a smartwatch solution, this interaction is strong since the smartwatch is directly set around the wrist of the human hand at a reduced distance. This section will analyze the impact of the human hand (Figure 4) over the evaluation board (Figure 1) considering different distances at the frequency region which covers from 2.4 GHz to 2.5 GHz.



**Figure 4** – Phantom hand used to assess the performance of the evaluation board (Figure 1) when regarding the human hand interaction.

#### 3.1. SET-UP

The evaluation board (Figure 1) is placed over a phantom hand emulating the electromagnetic properties of the human body at the frequency range of 2.4-2.5GHz at different distances (Figure 5).

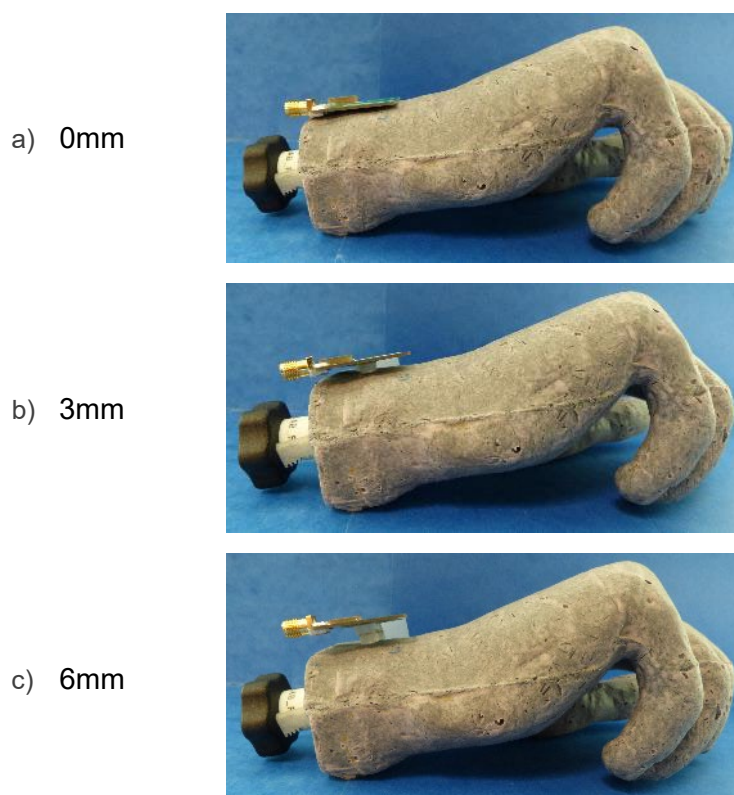

**Figure 5** – Different distances between the phantom hand and the evaluation board that provide operation from 2.4GHz to 2.5GHz.

### 3.2. MATCHING NETWORK

Please note that the matching network topology has been maintained for each configuration. The component values have been re-adjusted in each case for compensating the detuning effects introduced by the proximity of the phantom hand (Figure 5).

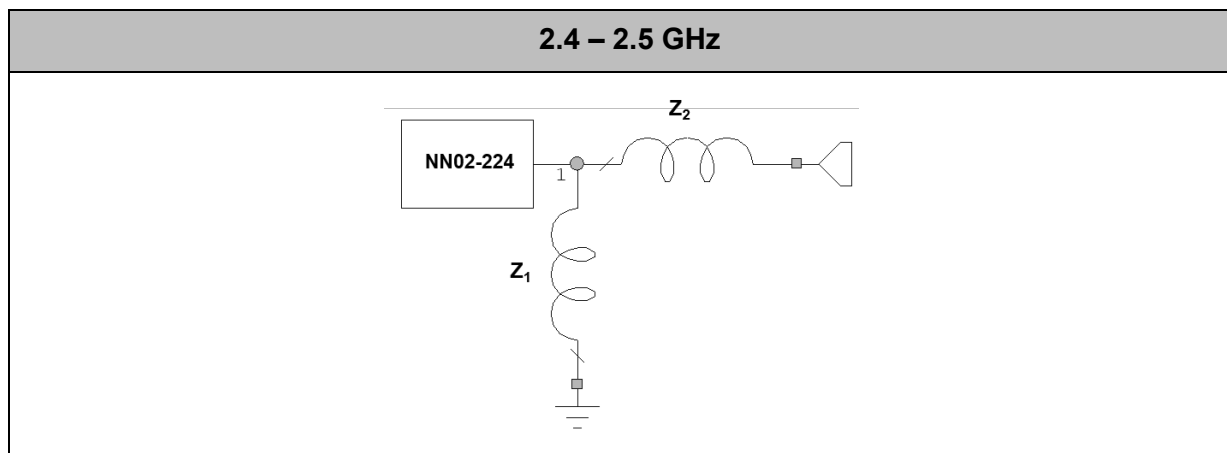

**Figure 6** – Topology of matching network mounted at the different solutions.

Distance	Z <sub>1</sub>	Z <sub>2</sub>
0mm	1.5 nH	0 Ω
3mm	1.8 nH	3.3 nH
6mm	1.8 nH	3.4 nH

**Table 3** – Values of the components for each distance.

Value		Part Number
Z1	1.5 nH	LQW15AN1N5C80
	1.8 nH	LQW15AN1N8C00
Z2	3.3 nH	LQW15AN3N3B80
	3.4 nH	LQW15AN3N4B80

**Table 4** – Values and part numbers of the components used for the matching networks.

### 3.3. VSWR AND TOTAL EFFICIENCY

VSWR (Voltage Standing Wave Ratio) and Total Efficiency versus Frequency (GHz).

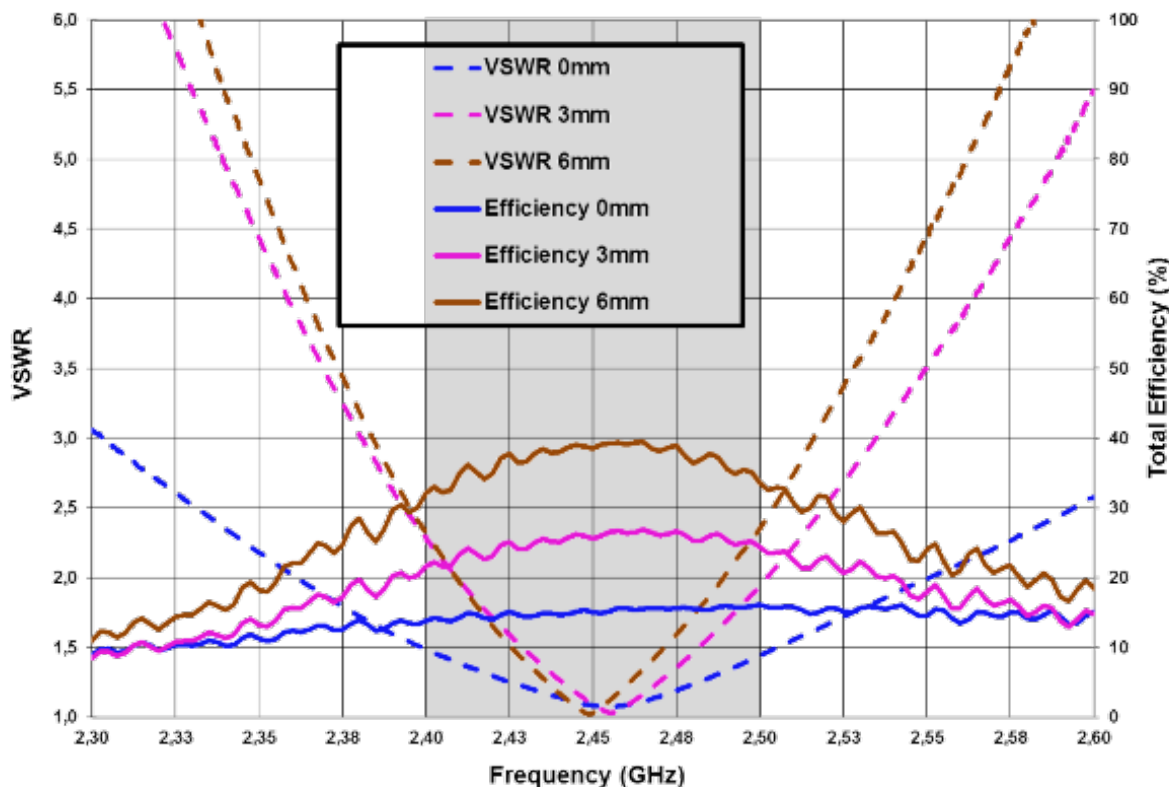

**Figure 7** – VSWR and Total Efficiency for the 2.4 – 2.5 GHz frequency range (from the evaluation board (Figure 5)).

Distance	VSWR	TOTAL EFFICIENCY (%)				
	2.4-2.5GHz	$\eta_a^2$ (2.4GHz)	$\eta_a$ (2.5GHz)	$\eta_a$ (min)	$\eta_a$ (max)	$\eta_a$ (average)
Free Space	< 2:1	76.0	75.5	74.5	81.2	78.6
0mm	< 2:1	13.8	16.1	13.8	16.1	15.1
3mm	< 2.5:1	21.6	24.4	21.6	26.9	25.0
6mm	< 2.5:1	32.1	33.6	32.1	39.5	37.0

**Table 5** – VSWR and Total Efficiency comparison considering the different distances.

<sup>2</sup>  $\eta_a$  refers to the total efficiency of the antenna system which considers both ohmic and impedance losses

### 3.4. RADIATION PATTERNS, GAIN AND EFFICIENCY

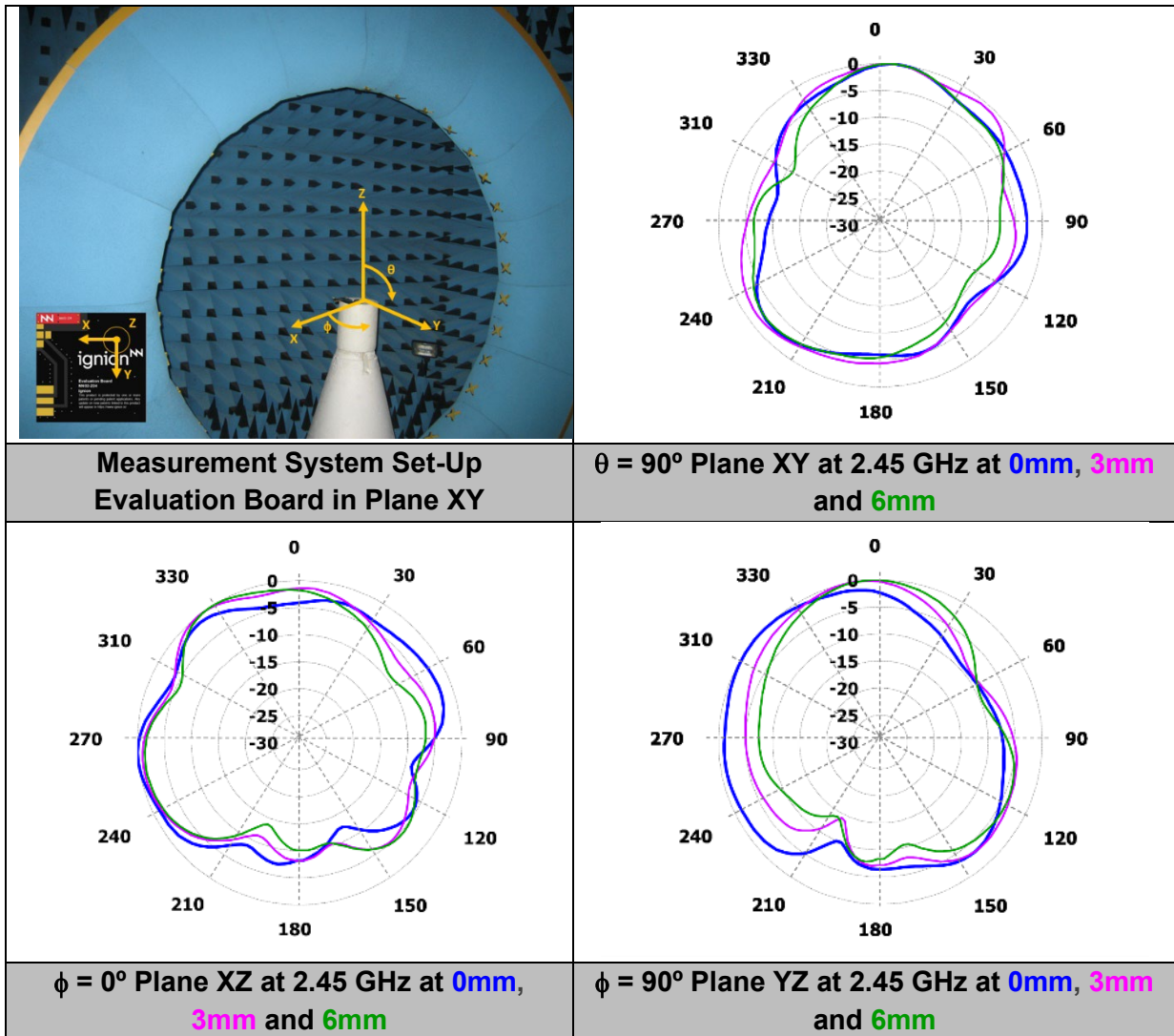

		0mm	3mm	6mm
Gain	Peak Gain	-3.5 dBi	0.3 dBi	3 dBi
	Average Gain across the band	-3.9 dBi	-0.3 dBi	2.6 dBi
	Gain Range across the band (min, max)	-4.5<-->-3.5 dBi	-1.2<-->0.3 dBi	1.7<-->3.0 dBi
Efficiency	Peak Efficiency	16.1 %	26.9 %	39.5 %
	Average Efficiency across the band	15.1 %	25.0 %	37.0 %
	Efficiency Range across the band (min, max)	13.8 – 16.1 %	21.6 – 26.9 %	32.1 – 39.5 %

**Table 6** – Antenna Gain and Total Efficiency from the Evaluation Board (Figure 1) within the 2.4 – 2.5 GHz frequency range. Measures made in the Satimo STARGATE 32 anechoic chamber.

ignion<sup>™</sup>

Your innovation.  
Accelerated.

Contact:  
[support@ignion.io](mailto:support@ignion.io)  
+34 935 660 710

#### **Barcelona**

Av. Alcalde Barnils, 64-68 Modul C, 3a pl.  
Sant Cugat del Vallés  
08174 Barcelona  
Spain

#### **Shanghai**

Shanghai Bund Centre  
18/F Bund Centre, 222 Yan'an Road East,  
Huangpu District  
Shanghai, 200002  
China

#### **New Delhi**

New Delhi, Red Fort Capital Parsvnath Towers  
Bhai Veer Singh Marg, Gole Market,  
New Delhi, 110001  
India

#### **Tampa**

8875 Hidden River Parkway  
Suite 300  
Tampa, FL 33637  
USA